

Model **EP17**

(FOR PUBERT)

PARTS CATALOG

**Spec. No. EX170DT1200
DU, URETHANE ELEMENT,
CABLE SPEED CONTROL,
FUELTANK, BLACK,
DEFLECTOR, RFI, EP2**

CONTENTS

1	CRANK CASE	108
2	CRANK SHAFT PISTON	208
3	INTAKE EXHAUST	308,318
4	GOVERNOR OPERATION	408
5	COOLING STARTING	508
6	FUEL LUBRICANT	608,648
7	ELECTRIC DEVICE	708
8	ACCESSORIES LABEL	908
9	SHIP LOOSE PART	1008

FIG. 108

(EP16/17)

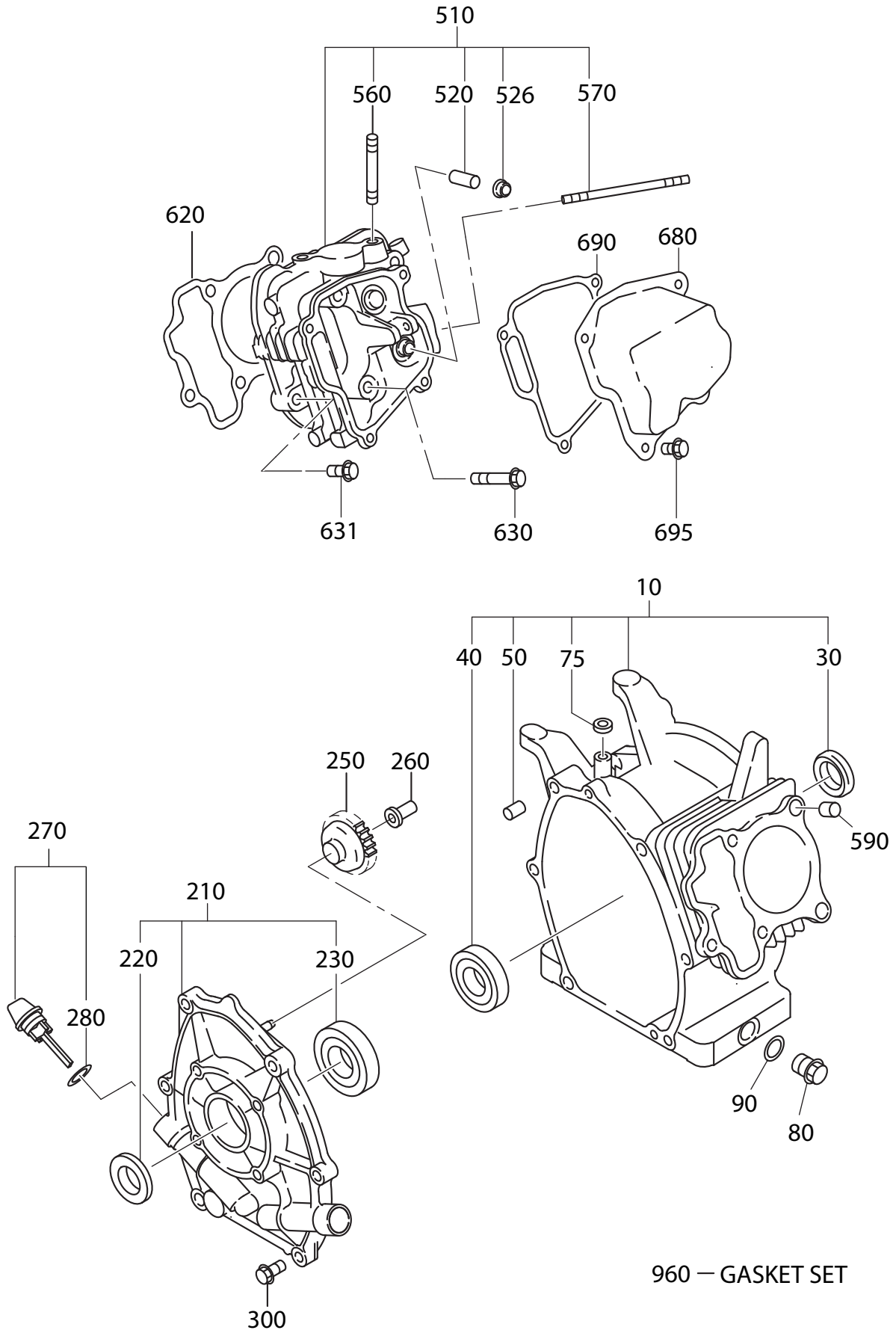

FIG. 208

(EP16/17)

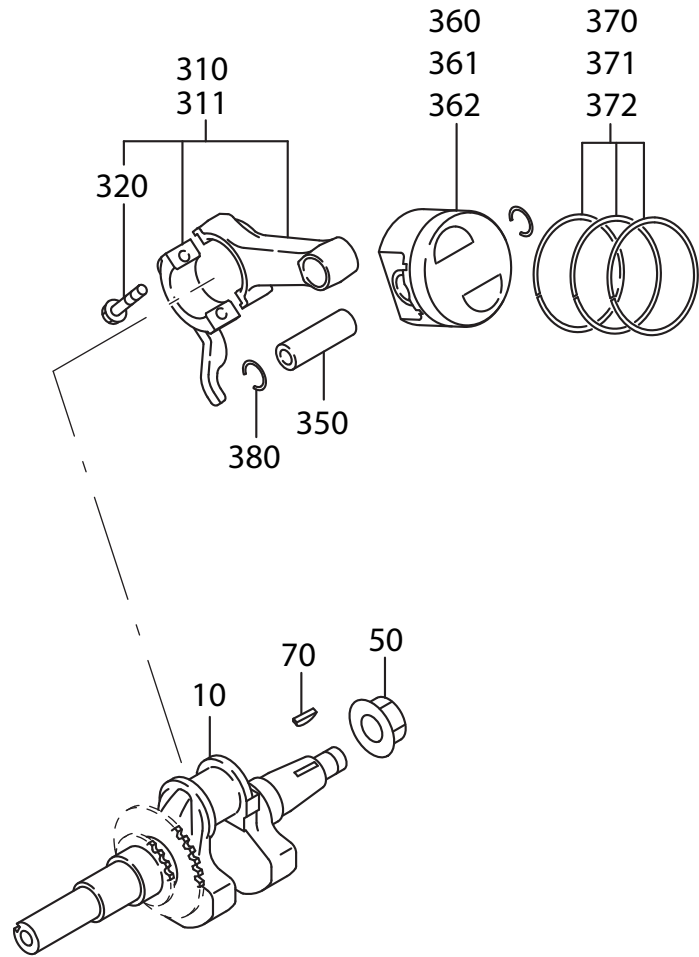
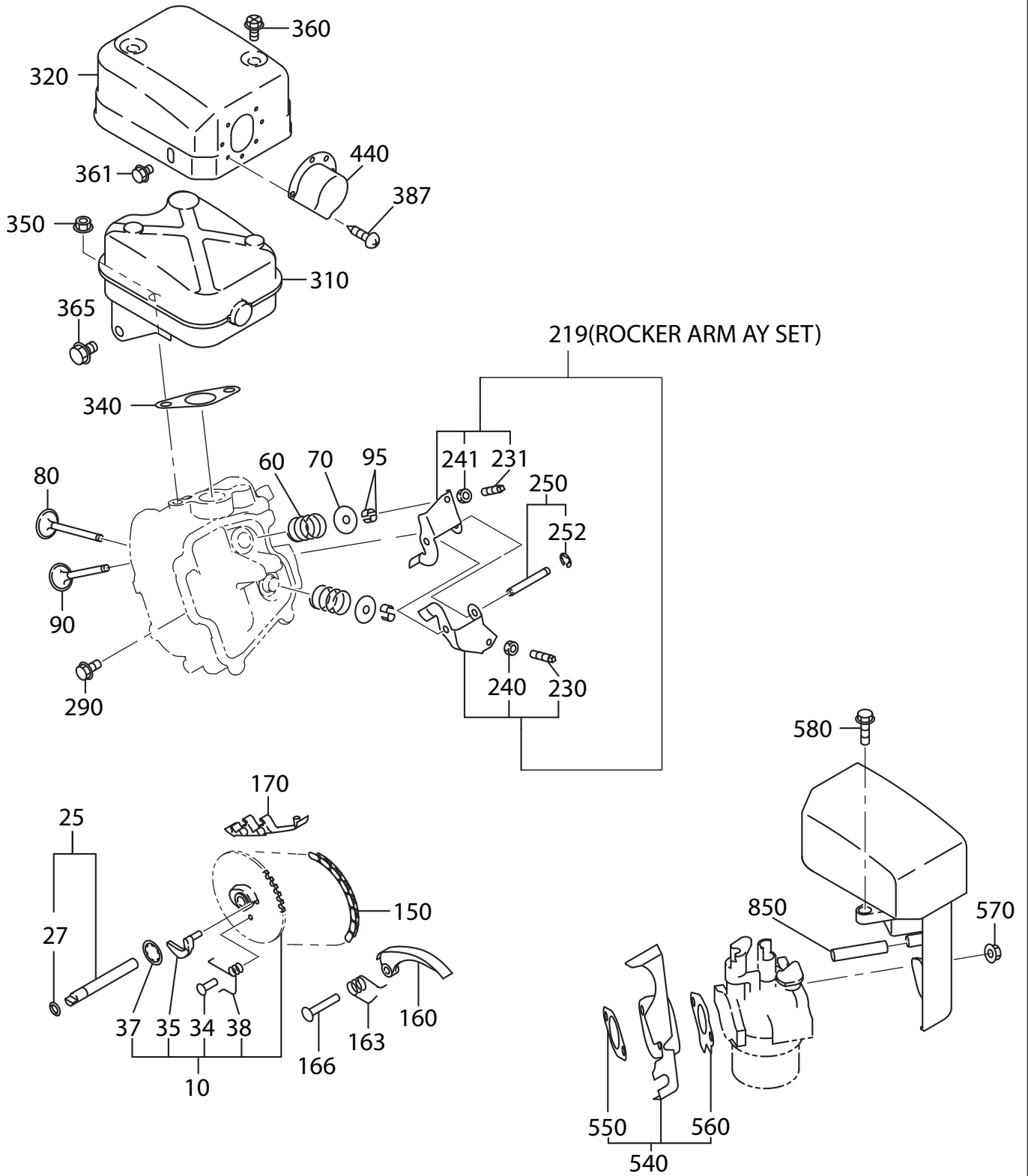

FIG. 308

(EP16/17)



3 INTAKE EXHAUST

EX170DT1200

REF.	PART NUMBER	PART NAME	QTY	R E M A R K S	CODE NO.	INTERCHANGE	FIG.
10	277-31601-31	CAM SHAFT CP	1	85DX2. 9B N=40	-		308
25	277-35101-01	PIN(CAM SHAFT) CP	1	9DX78. 5L	-		308
27	024-00600-10	O RING	1	5. 8DX1. 9D	-		308
34	277-38601-03	PIN(SPRING)	1	4DX8DX9L	-		308
35	277-36401-03	RELEASE LEVER	1		-		308
37	277-36501-03	CLIP	1	13. 8DX20. 3DX0. 4T	-		308
38	277-38702-03	RETURN SPRING	1	5. 1DX0. 6DX4. 4L N=7	-		308
60	279-33601-03	VALVE SPRING	2	19. 2DX2. 3DX27. 4L	-		308
70	269-33701-03	SPRING RETAINER	2		-		308
80	277-33401-H3	INTAKE VALVE	1	25. 5DX5. 5DX68. 1L	-		308
90	277-33501-H3	EXHAUST VALVE	1	23. 5DX5. 5DX68. 1L	-		308
95	132-10KA0-31	COLLET-VALVE	4		-		308
150	277-35601-11	TIMING CHAIN CP	1	88 LINK	-		308
160	277-36911-03	TENTIONER	1		-		308
163	277-37101-03	SPRING(TENTIONER)	1	10DX1. 8DX14L N=4. 5	-		308
166	277-36902-03	PIN(TENTIONER)	1	6DX13DX34L	-		308
170	277-36913-13	CHAIN GUIDE	1		-		308
219	277-36001-07	ROCKER ARM AY SET	1		-		308
		ROCKER ARM(IN) AY	1	Replace with ROCKER ARM(EX) AY	-		308
		ROCKER ARM(EX) AY	1	Replace with ROCKER ARM(IN) AY	-		308
230	014-90500-20	ADJUST SCREW	1	M5X0. 5X23L	-		308
231	014-90500-20	ADJUST SCREW	1	M5X0. 5X23L	-		308
240	017-00500-30	NUT	1	M5X0. 5X4. 1H	-		308
241	017-00500-30	NUT	1	M5X0. 5X4. 1H	-		308
250	277-35002-01	PIN(ROCKER) CP	1	6DX46L	-		308
252	003-13050-00	CLIP	1	5DX11DX0. 6T	-		308
290	011-00600-20	FLANGE BOLT	1	M6X1. 0X14DX12L	-		308
310	277-30101-J1	MUFFLER CP	1		-		308
320	277-34204-21	MUFFLER COVER CP	1		-		308
340	277-35201-13	GASKET(MUFFLER)	1	T=0. 2 26D 9DX58P	-		308
350	980-20082-80	FLANGE NUT	2	MUFFLER	-		308
360	015-20600-90	TAPPING BOLT	2	M6X13DX10L MUF-COV(TOP)	-		308
361	011-00600-10	FLANGE BOLT	1	M6X1. 0X8L MUF-COV(SIDE)	-		308
365	011-00803-20	FLANGE BOLT	1	M8X1. 25X16DX12L MUFFLER	-		308
387	015-00400-60	TAPPING SCREW	2	M4X6L DEFLECTOR	-		308
440	277-37001-H1	DEFLECTOR CP	1	T=0. 8 WITH SCREEN	-		308

FIG. 318

(EP16/17)

URETHANE FOAM

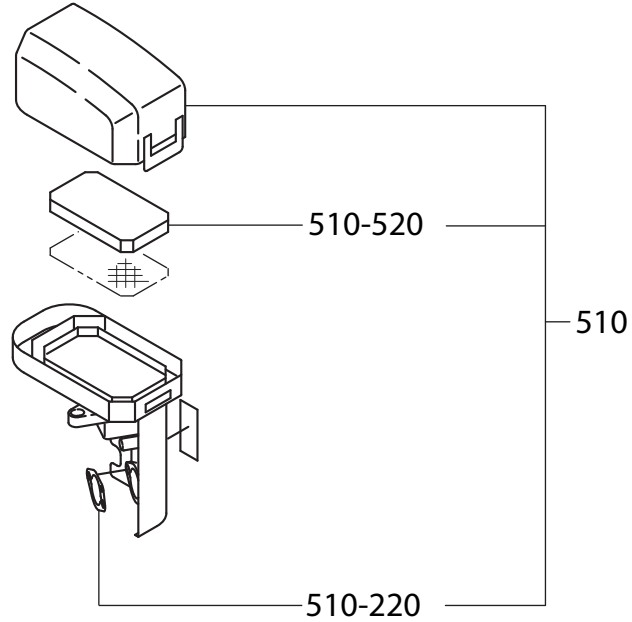

OIL BATH(EP17)

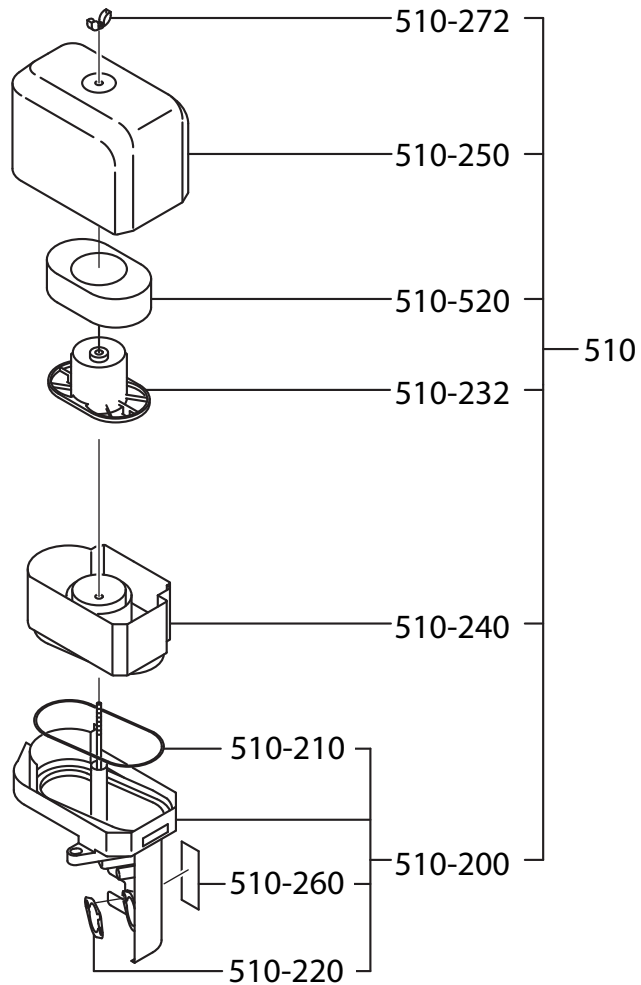

FIG. 408

(EP16/17)

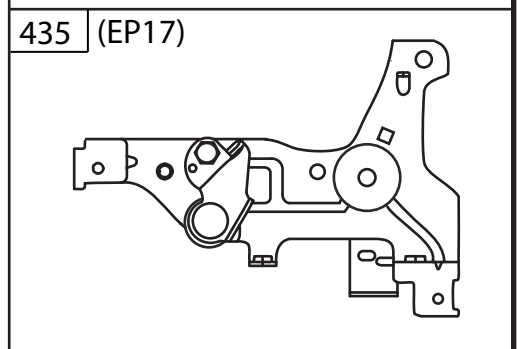
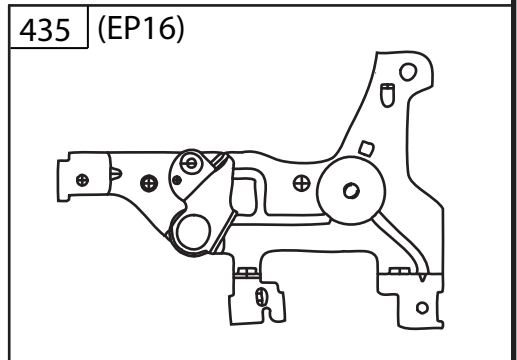
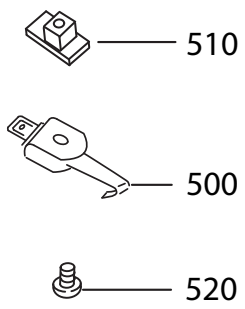
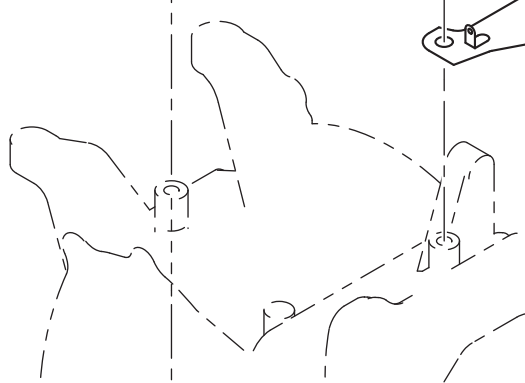
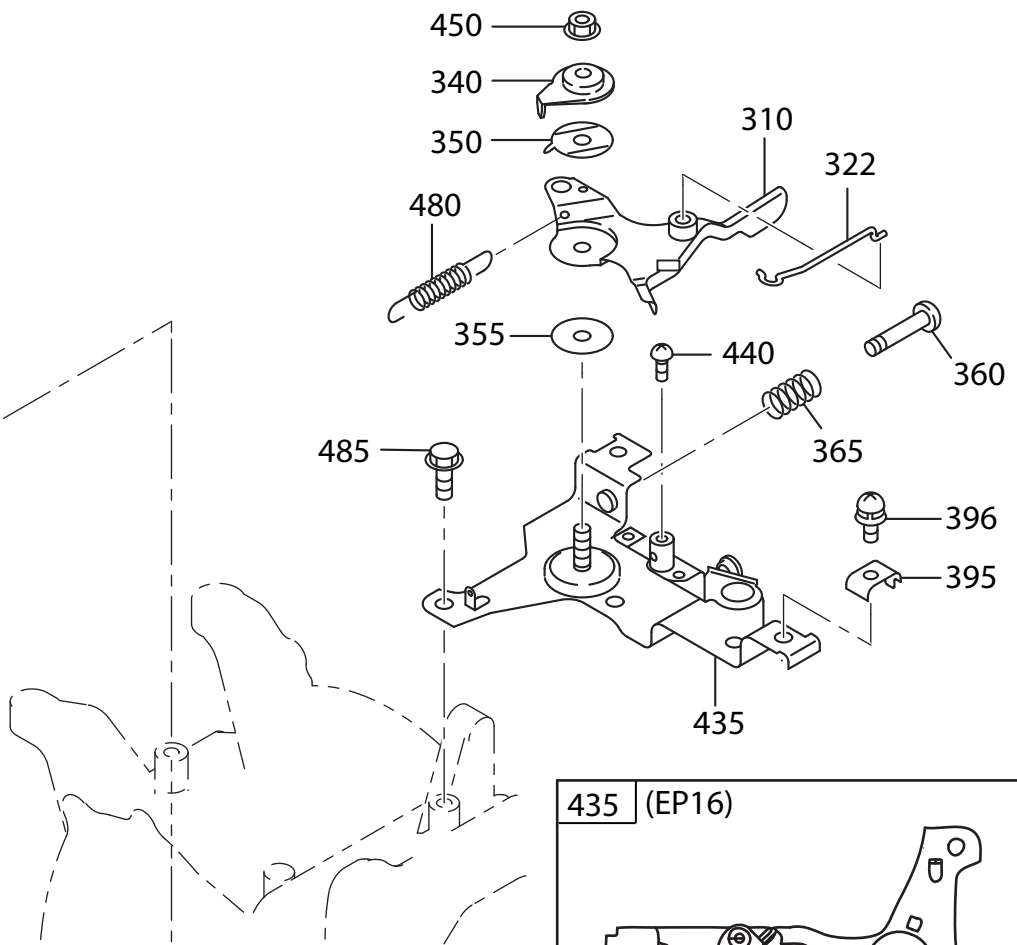
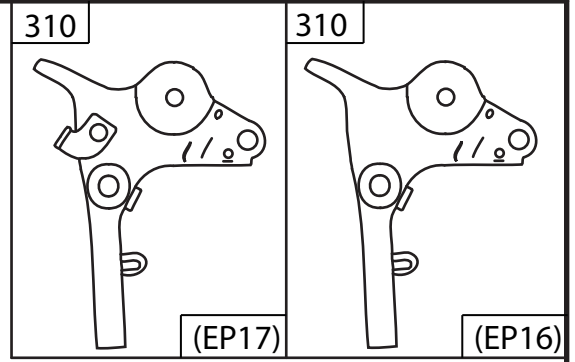
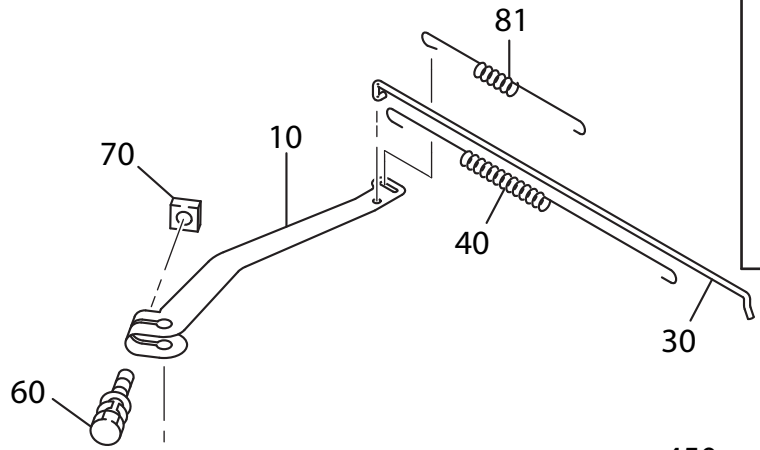

FIG. 508 (EP17)

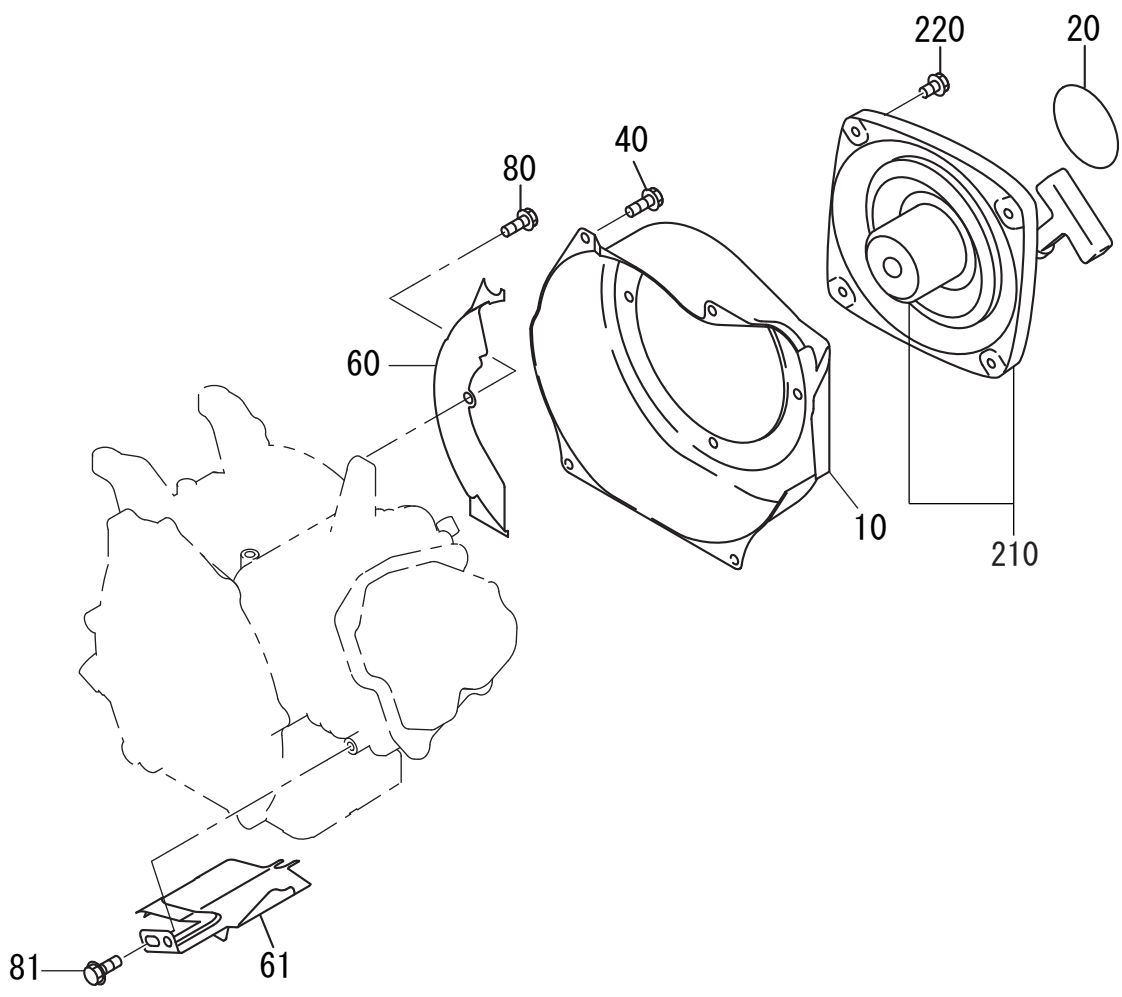

FIG. 608

(EP16/17)

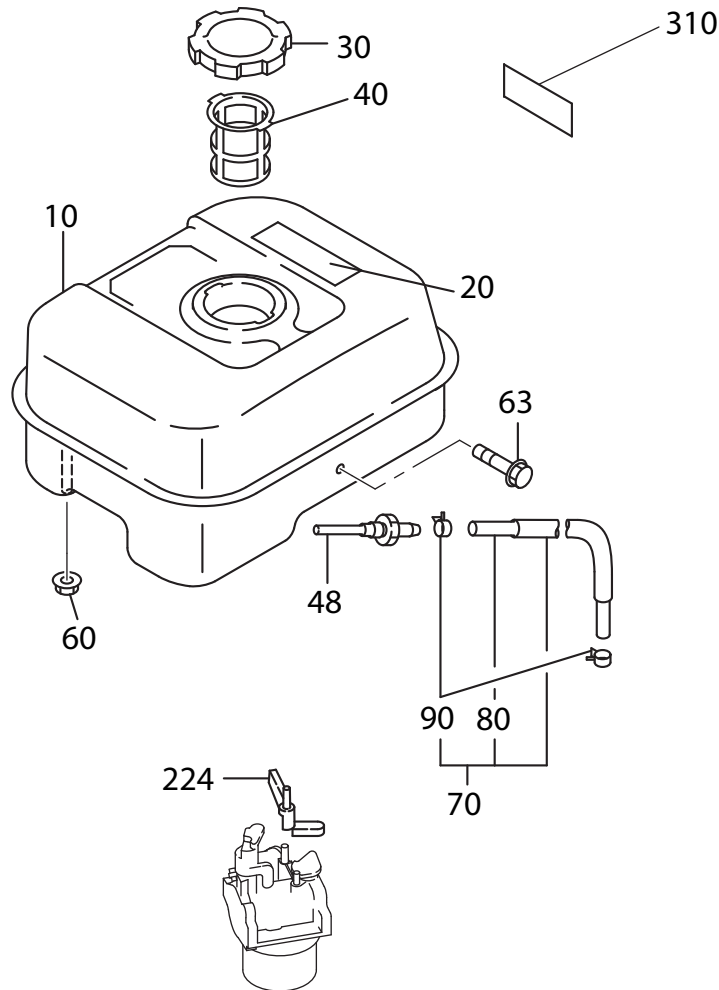

FIG. 648

(EP16/17)

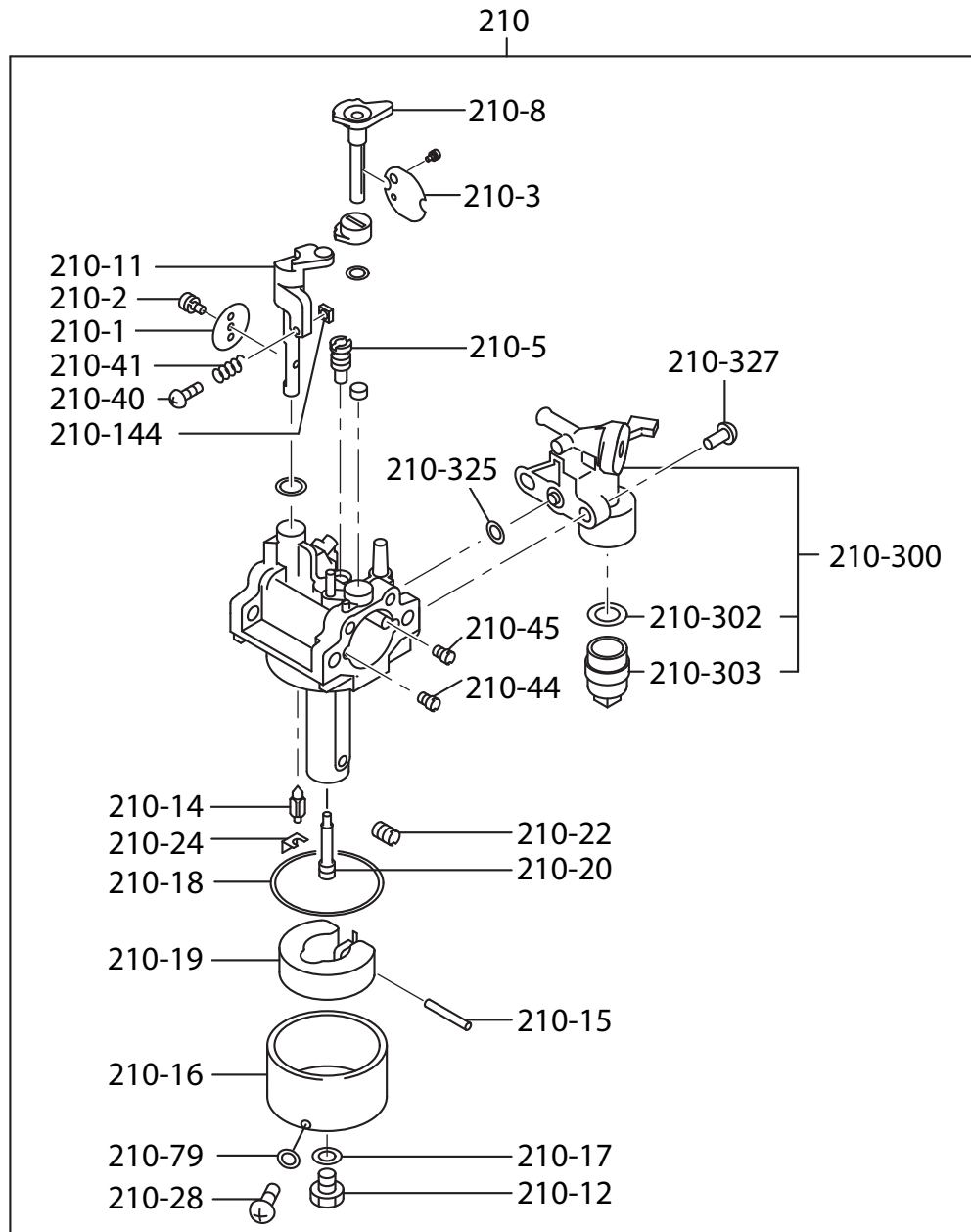

FIG. 708

(EP16/17)

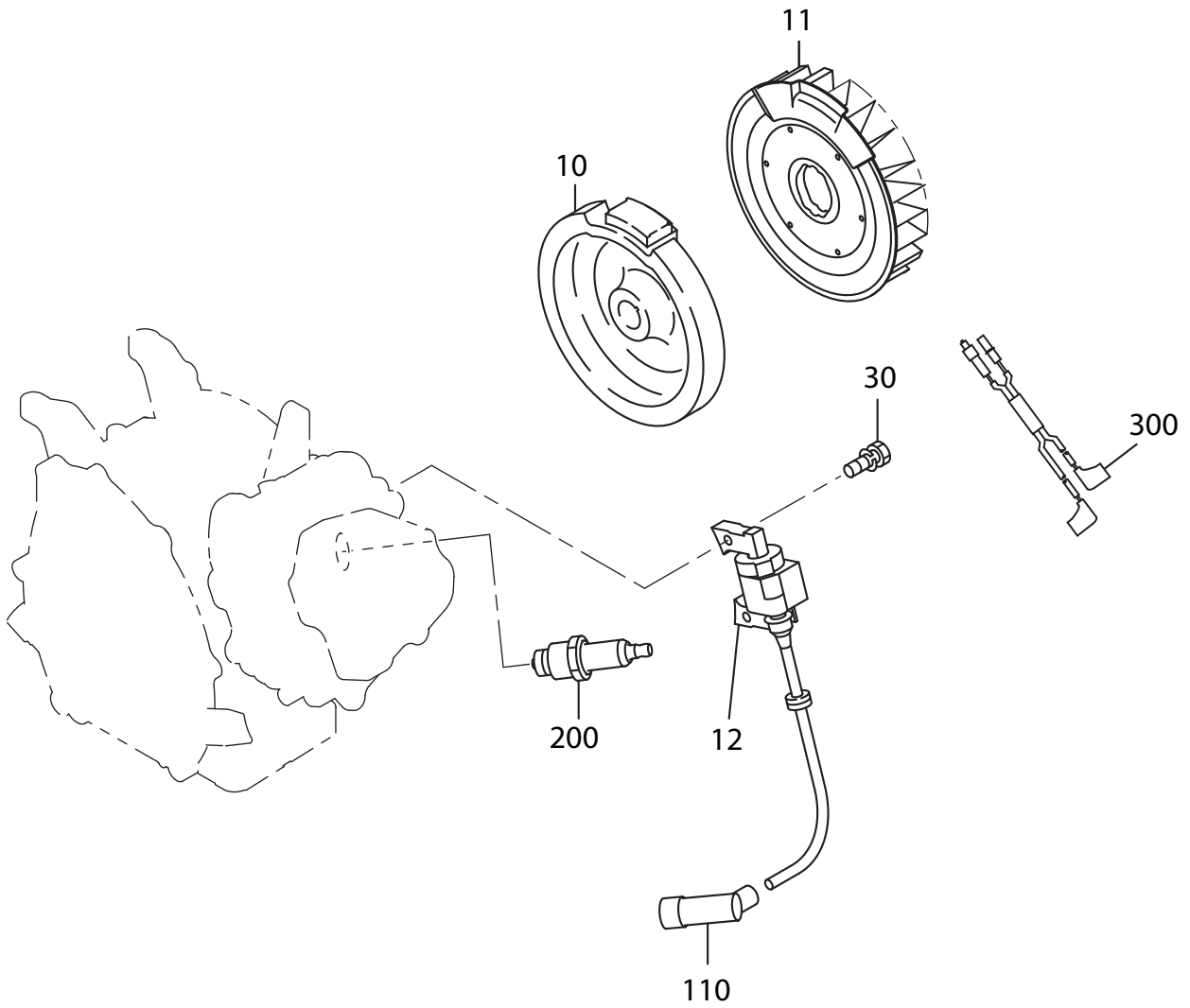

FIG. 908

(EP16/17)

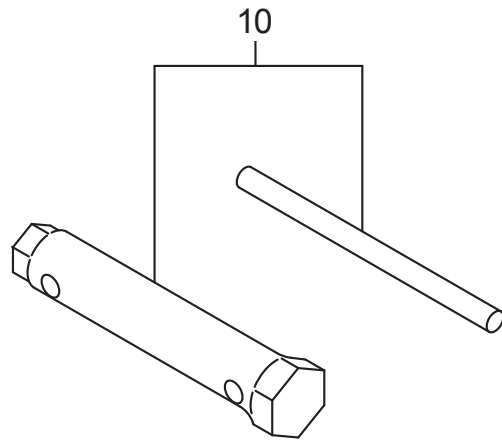

FIG. 1008

(EP16/17)



